

TECHNICAL SPECIFICATION

COLOURS

DESKS, CONFERENCE TABLES - WORKTOP



111 LIGHT  
SYCAMORE



112 DARK  
SECAMORE

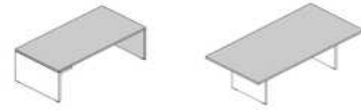

DESKS, CONFERENCE TABLES - BASE HPL



73 HIGH GLOSS  
WHITE



101 HIGH GLOSS  
BLACK

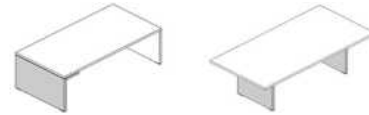

COLUMN COLOUR



M115 BLACK  
SEMI-MATTE



M009 ALUMINUM  
SEMI-MATTE

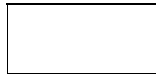

M015 WHITE  
SEMI-MATTE



MODULAR TABLES MIT06, MIT07, MIT08



111 LIGHT  
SYCAMORE



112 DARK  
SECAMORE



MANAGERIAL STORAGE, PEDESTAL, MOBILE PEDESTAL MIT130



111 LIGHT  
SYCAMORE



112 DARK  
SECAMORE

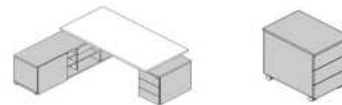

MANAGERIAL STORAGE EXTENSION MIT5

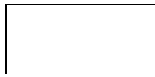

73 HIGH GLOSS  
WHITE



101 HIGH GLOSS  
BLACK



STORAGE - BODY



111 LIGHT  
SYCAMORE



112 DARK  
SECAMORE



STORAGE - FRONT (MIT8 , MIT15)



111 LIGHT  
SYCAMORE



112 DARK  
SECAMORE



STORAGE - FRONT HPL (MIT7 , MIT18, MIT19, MIT20, MIT21, MIT22)

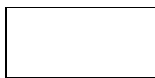

73 HIGH GLOSS  
WHITE



101 HIGH GLOSS  
BLACK



TECHNICAL SPECIFICATION

COLOURS

MOBILE PEDESTAL SLD



67 WHITE PASTEL



73 HIGH GLOSS WHITE



08 BLACK



101 HIGH GLOSS BLACK



CUSHION SKP13 - FABRIC NEMO



NE-1 BEIGE



NE-2 YELLOW



NE-3 ORANGE



NE-5 RED



NE-9 GREEN

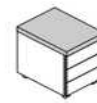

NE-10 GREY



NE-14 DARK GREY



NE-15 NAVY BLUE



NE-16 BLACK



NE-17 BLUE

CUSHION SKP13 - FABRIC RUNNER - SECOND GROUP



R-63034 ORANGE



R-64089 RED



R-66063 BLUE



R-60011 GREY



R-68056 GREEN

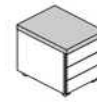
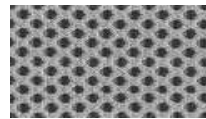

R-66064 NAVY-BLUE



R-60999 BLACK



R-60025 DARK GREY



R-61128 BEIGE

CUSHION SKP13 - FABRIC MEDLEY - SECOND GROUP



M-68005 DARK OLIVE



M-68002 LIGHT OLIVE



M-68115 GREEN



M-61002 BEIGE



M-67053 NAVY BLUE

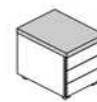

M-67006 LIGHT BLUE



M-66008 GREY



M-64019 RED



M-63064 PINK



M-60999 BLACK

CUSHION SKP13 - FABRIC ATLANTIC - SECOND GROUP



A-67043 DARK TURQUOISE



A-67030 SEA-GREEN



A-60141 LIGHT GREY



A-60011 GREY



A-66064 NAVY BLUE

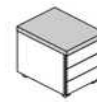

A-65037 VIOLET



A-62048 OLIVE



A-64089 RED



A-61078 BEIGE



A-60025 GRAPHITE

TECHNICAL SPECIFICATION

COLOURS

CUSHION SKP13 - FABRIC BLAZER - THIRD PRICE GROUP



CUZ39 ORANGE



CUZ63 RED



CUZ1L GREEN



CUZ12 GRAPHITE



CUZ02 TURQUOISE

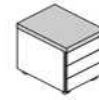

CUZ1V BLUE



CUZ1X PINK



CUZ1G GREY



CUZ28 LIGHT GREY



CUZ47 BEIGE



CUZ1R -  
SEA-GREEN

CUSHION SKP13 - FABRIC XTREME - THIRD PRICE GROUP



XR160 SEA-GREEN



XR430 DARK  
TURQUOISE



XR026 NAVY BLUE

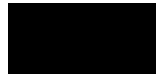

XR084 VIOLET

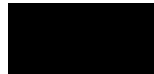

XR009 BLACK



XR420 OLIVE



XR081 DARK GREY



XR094 GREY



XR108 BEIGE



XR079 RED

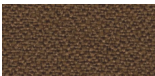

YS158 BROWN



YS083  
BLUE-GREY



YS071  
LIGHT BROWN



YS166 SAND BROWN

TECHNICAL SPECIFICATION

DESKS

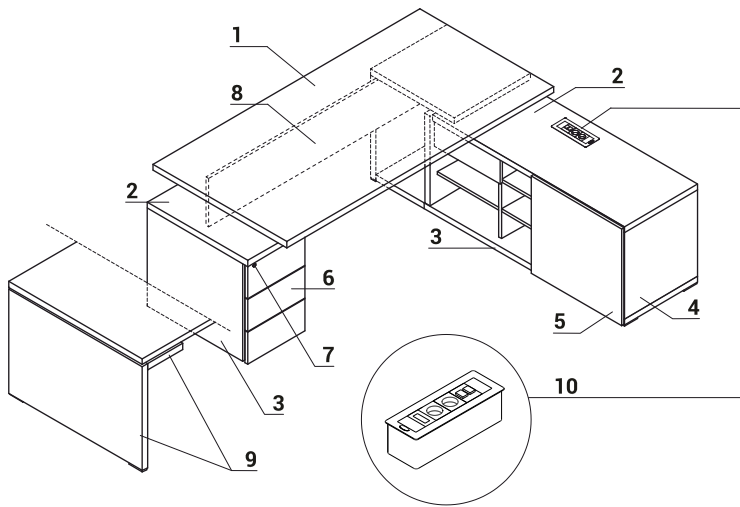

- 1. **Worktop** - MFC 1 4/8" | 38mm, PVC edge
- 2. **Top** - MFC 1 4/8" | 38mm, PVC edge
- 3. **Base** - MFC 1 4/8" | 38mm, PVC edge
- 4. **Body** - MFC 6/8" | 18mm, PVC edge
- 5. **Sliding front** - MFC 6/8" | 18mm, PVC edge
- 6. **Front** - MFC 6/8" | 18mm, PVC edge
- 7. **Central lock** - foldable key
- 8. **Modesty panel** - MFC 6/8" | 18mm, PVC edge
- 9. **HPL base** - high gloss - 1 4/8" | 38mm
- 10. **Option with additional charge Mediaport S91E** - 2x 110V, 2x RJ45

POSSIBLE CONFIGURATIONS

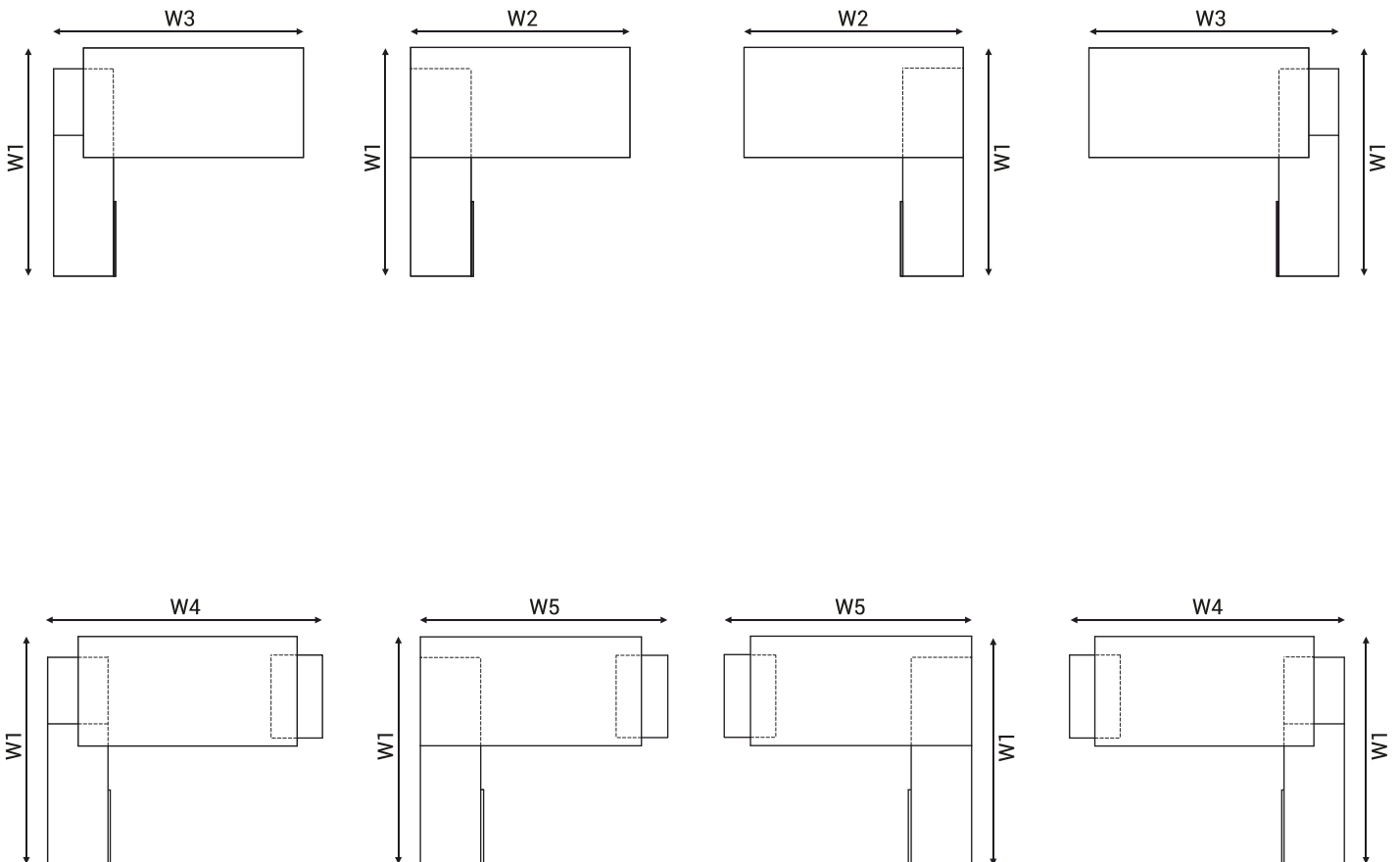

W1 - 81 7/8" (2080mm) | W2 - 70 7/8" / 78 6/8" (1800x2000mm) | W3 - 81 6/8" / 89 5/8" ( 2078x2278mm) | W4 - 90 3/8" / 98 2/8" (2297x2497mm)| W5 - 79 4/8" / 87 3/8" (2019x2219mm)

**TECHNICAL SPECIFICATION**

**DESK WITH ELECTRIC ADJUSTMENT SIT-STAND**

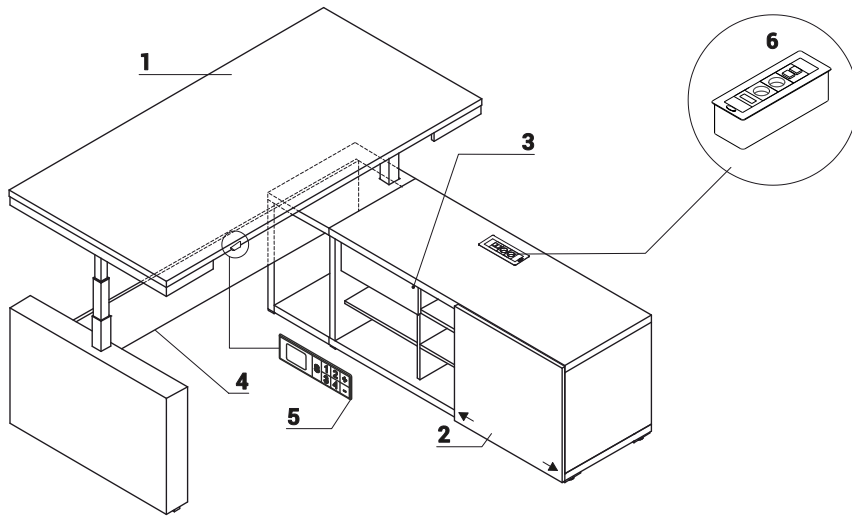

1. **Worktop** - MFC 1 4/8" | 38mm, PVC edge
2. **Sliding front** - MFC 6/8" | 18mm, PVC edge
3. **Drawer** - MFC 6/8" | 18mm, PVC edge, possible different position
4. **Electric height adjustable base** - powder coated steel, load 100kg, telescopic leg 2 3/8" / 2 3/8" (60x60mm), 2" / 2" (50x50mm) , 1 5/8" / 1 5/8" (40x40mm)
5. Control panel
6. **Option with additional charge Mediaport S91E** - 2x 110V, 2x RJ45
7. Cable grommets

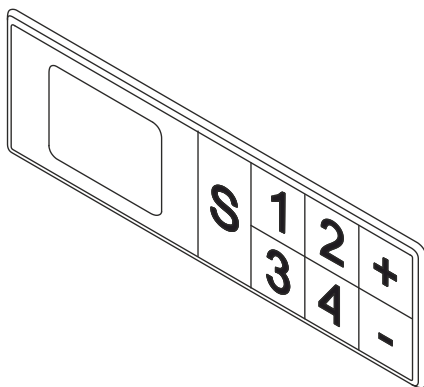
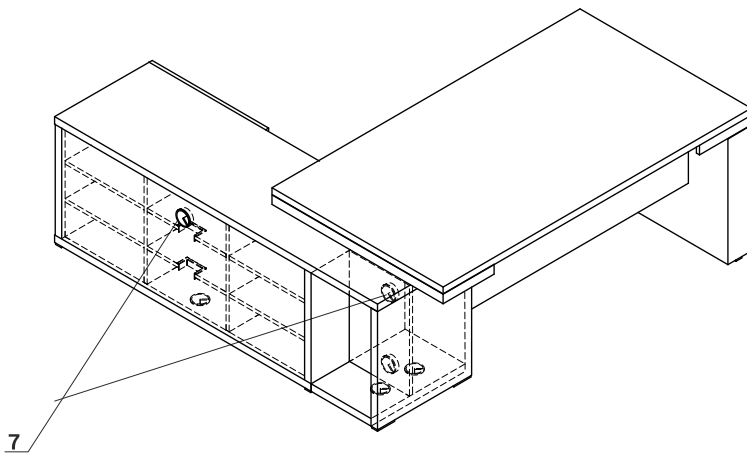

**FRAME TECHNICAL SPECIFICATION**

**Height adjustment** - 1 5/8" | 40mm /sec Super Soft Start - Stop

**Drive** - 2 synchronised motors with microprocessor, work control sensor

**ISP** - Intelligent System Protection

**Norms** - ISO 21016, EN 527-2, EN 527 -3  
EU Directives 206/95EC, UI508 1999, UL 1004 R7 06, WE DC 2004/108WE

**Power supply** - 230V, 300W, power consumption on Standby - 0.3W

**TECHNICAL SPECIFICATION**  
**POSSIBLE CONFIGURATIONS**

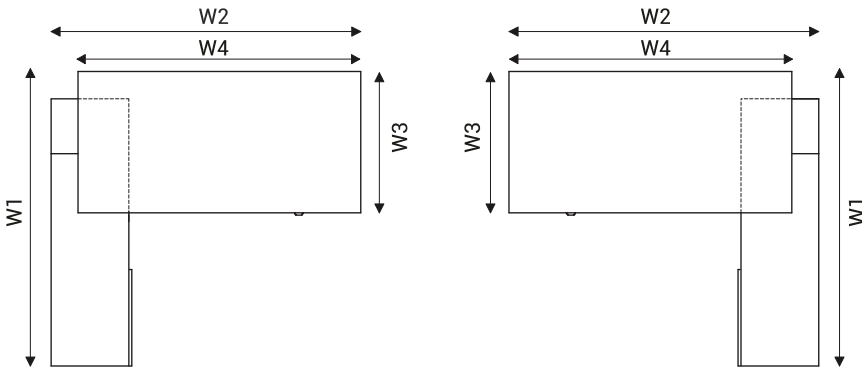

W1 - 81 7/8" 2080mm|W2 - 78 3/8"x86 2/8" 1990x2190mm|W3 - 39 3/8" 1000mm|W4 - 70 7/8"x78 6/8" 1800x2000mm

**MANAGERIAL STORAGE**

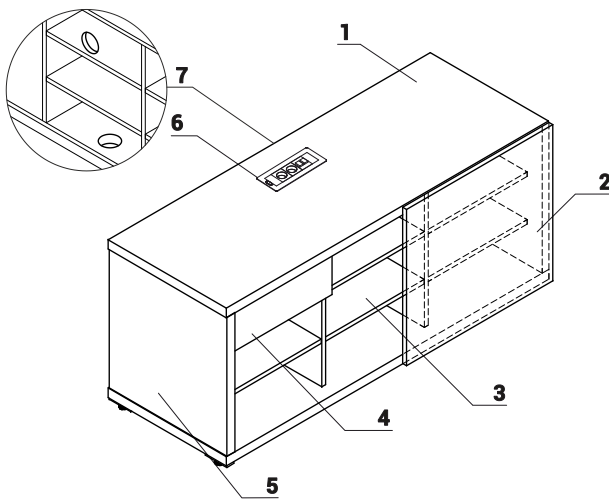

1. **Top** - MFC 1 4/8" | 38mm, PVC edge
2. **Front** - MFC 6/8" | 18mm, PVC edge
3. **Interior** - MFC 6/8" | 18mm
4. **Drawer** - MFC 6/8" | 18mm, PVC edge, lock - possible to change location
5. **Side panels** - MFC 1 4/8" | 38mm, PVC edge
6. **Option with additional charge Mediaport S91E** - 2x 110V, 2x RJ45
7. **Cable grommets** - O3 1/8" | O80mm

**DISC BASE MEETING TABLES**

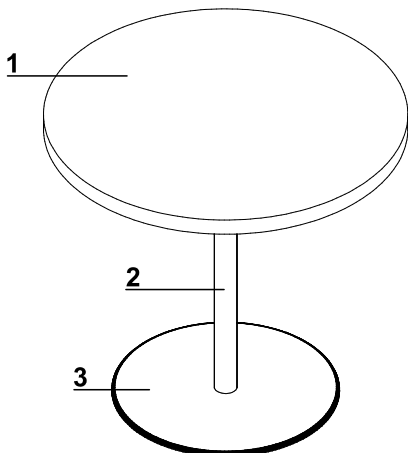

1. **Worktop** - MFC 1 4/8" | 38mm, PVC edge
2. **Column** - powder coated steel
3. **Disc** - stainless steel

**TECHNICAL SPECIFICATION**

**MFC BASE MEETING TABLES**

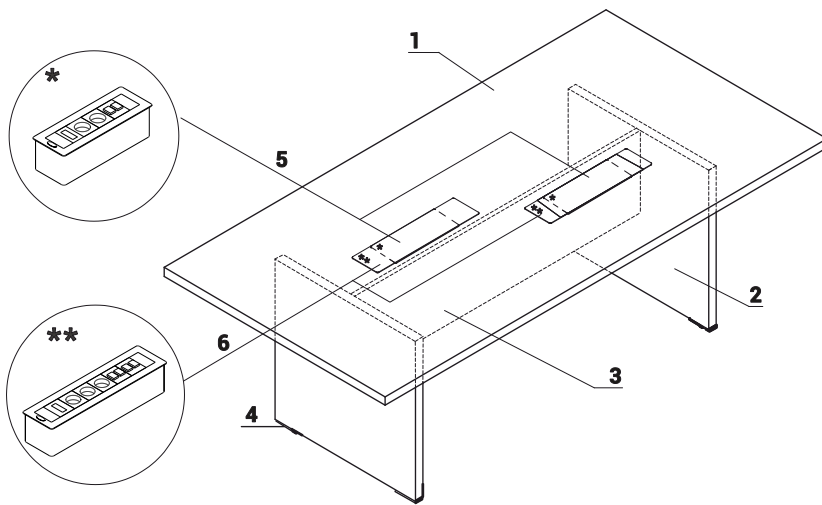

1. **Worktop** - MFC 1 4/8" | 38mm, PVC edge
2. **HPL base** - high gloss - 1 4/8" | 38mm
3. **Modesty panel** - MFC 6/8" | 18mm, PVC edge
4. **Leveling** - 2/8" | 5mm range
5. **Option with additional charge Mediaport S91E** - 2x 110V, 2x RJ45
6. **Option with additional charge - Mediaport S92E** - 3 x 110V, 4 x RJ45

ATTENTION: For tables MIT06, MIT07, MIT08 conference tables with mediaboxes can be ordered as option. To order add a letter at the end of a product index: Mediabox S91E : Locations A,B (1pcs – extra charge 528,-), or C (2pcs – extra charge 1056,-) | - Mediaport S92E: Locations G,H (1pcs - 800,-), or K(2pcs - 1600,-).

**STORAGES**

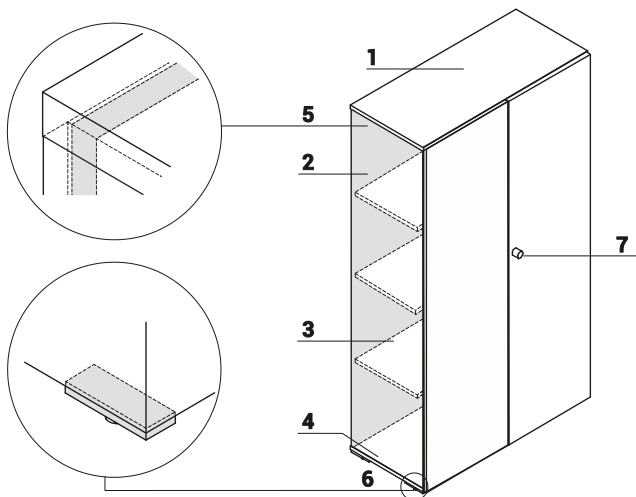

1. **Top** - MFC 6/8" | 18mm, PVC edge
2. **Side panels** - MFC 6/8" | 18mm, PVC edge
3. **Shelf** - MFC 6/8" | 18mm, PVC edge
4. **Base** - MFC 6/8" | 18mm, PVC edge
5. **Back MFC** - 6/8" | 18mm, PVC edges
6. **Leveling** - 2/8" | 5mm range
7. Espagnolette lock in doorknob

**SLIDING DOOR STORAGES**

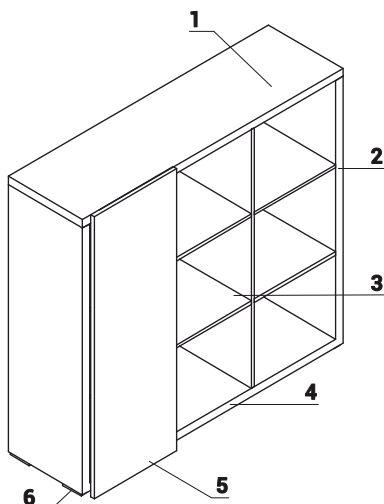

1. **Top** - MFC 1 4/8" | 38mm, PVC edge
2. **Side panels** - MFC 1 4/8" | 38mm, PVC edge
3. **Interior** - MFC 6/8" | 18mm
4. **Base** - MFC 1 4/8" | 38mm, PVC edge
5. **Sliding front** - MFC 6/8" | 18mm, PVC edge
6. **Leveling** - 2/8" | 5mm range

Sliding front storages MIT7 / MIT18

**TECHNICAL SPECIFICATION**  
**SUSPENSION FILES STORAGE**

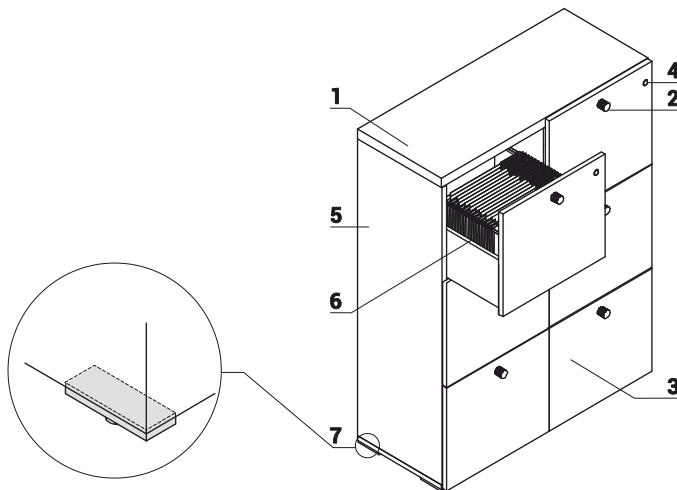

1. **Top** - MFC 1 4/8" | 38mm, PVC edge
2. Aluminium handle
3. **Front** - HPL - high gloss
4. **Central lock** - foldable key
5. **Side panels** - MFC 6/8" | 18mm, PVC edge
6. **Suspension files drawer** - MFC 6/8" | 18mm, ball runners, max load 45kg, 100% extraction
7. **Leveling** - 2/8" | 5mm range

**MOBILE PEDESTAL MIT130**

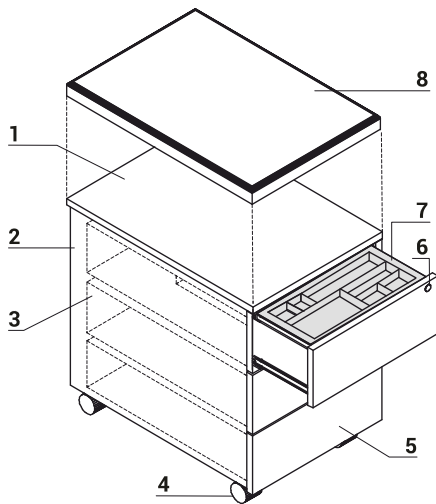

1. **Top** - MFC 6/8" | 18mm, PVC edge
2. **Body** - MFC 6/8" | 18mm, PVC edge
3. **MFC drawer** - ball runners, max load 25kg, 100% extraction; Anti - tilt mechanism, soft closing
4. **Castors** - O2" | O50mm, two with brakes
5. **Front** - MFC 6/8" | 18mm, PVC edge
6. **Central lock** - foldable key
7. **Pencil tray** - black plastic
8. **Cushion SKP13** - for pedstal, order separately, max load 120kg

ATTENTION - no sitting on pedestals without castors support; to be ordered with cushion SKP13

**MOBILE PEDESTAL WITHOUT HANDLES**

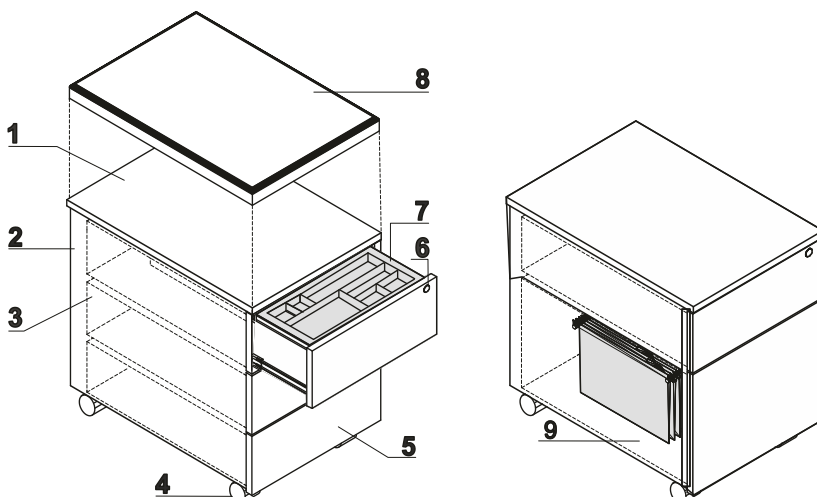

1. **Top** - MFC 6/8" | 18mm, covered with high gloss HPL
2. **Body** - MFC 6/8" | 18mm, PVC edge
3. **Metal drawer** - roll runners, max load 25kg, 80% extraction; Anti - tilt mechanism; OPTIONAL: ball runners, soft closing
4. **Castors** - O2" | O50mm, two with brakes
5. **Front** - HPL 6/8" | 18mm - high gloss, PVC edge
6. **Central lock** - foldable key
7. **Pencil tray** - black plastic
8. **Cushion SKP13** - for pedstal, order separately, max load 120kg
9. **Suspension files drawer** - ball runners, max load 30kg, 100% extraction, A4 folders must be inserted parallelly to the front



ATTENTION - no sitting on pedestals without castors support; to be ordered with cushion SKP13

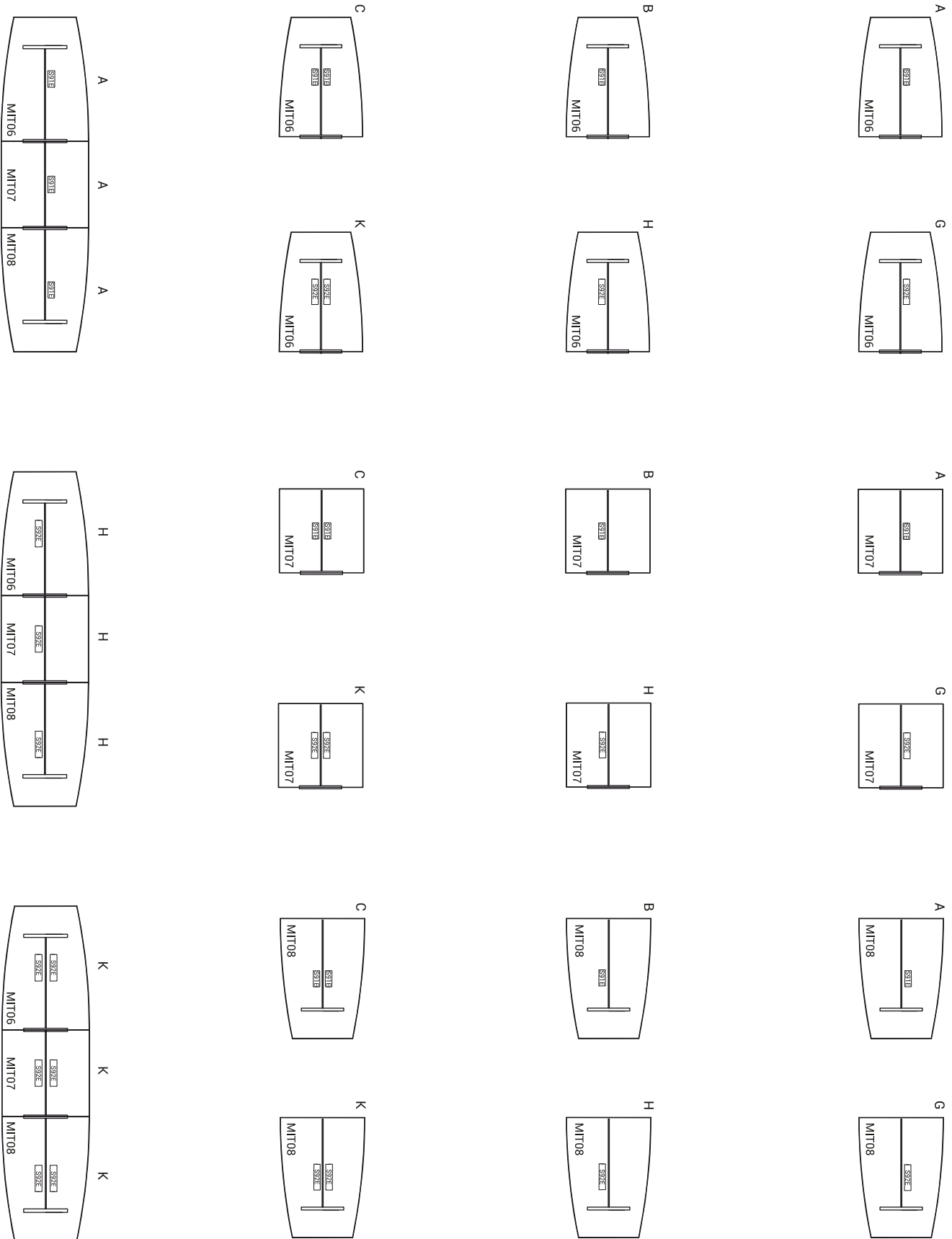

POSSIBLE MEDIAPORT LOCATION



TO ORDER PRODUCT WITH MEDIABOX, AT THE END OF THE SYMBOL SHOULD BE ADDED A LETTER (A,B,...) WHICH IS CORRESPONDING TO THE SELECTED CONFIGURATION (EX. X01A)

PRODUCT ILLUSTRATION	DIMENSIONS [mm]/[inch]			INDEX SYMBOL						COMMENTS
	WIDTH	DEPTH	HEIGHT			kg	m3	pcs		

**DESKS**

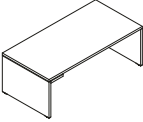
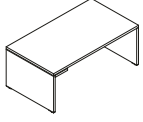
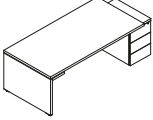
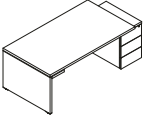

	2000 78 3/4"	1000 39 3/8"	740 29 1/8"	<b>MIT3</b>		97.7	0.274	4		
	1800 70 7/8"	1000 39 3/8"	740 29 1/8"	<b>MIT4</b>		92.7	0.258	4		
	2219 87 3/8"	1000 39 3/8"	740 29 1/8"	<b>MIT3KD</b>		123.7	0.482	4		universal left or right
	2019 79 1/2"	1000 39 3/8"	740 29 1/8"	<b>MIT4KD</b>		118.7	0.465	4		universal left or right

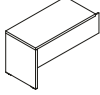
**DESK EXTENSION**

	1200 47 1/4"	600 23 5/8"	740 29 1/8"	<b>MIT12</b>		32.4	0.085	3		MIT3 and MIT4 - not possible to fix from HPL panel side
--	-----------------	----------------	----------------	--------------	--	------	-------	---	--	---

**DESK PAD**

	416 16 3/8"	600 23 5/8"	5 1/4"	<b>S100</b>		1.0	0.001	0		eco leather- color black
---	----------------	----------------	-----------	-------------	--	-----	-------	---	--	--------------------------

PRODUCT ILLUSTRATION	DIMENSIONS [mm]/[inch]			INDEX SYMBOL						COMMENTS
	WIDTH	DEPTH	HEIGHT			kg	m3	pcs		

**DESKS WITH MANAGERIAL SIDE STORAGE**

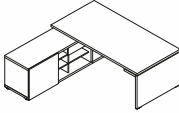
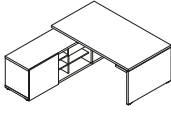
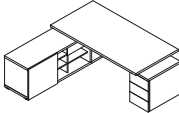
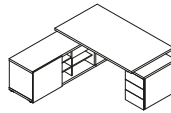
	2278 2000 89 5/8" 78 3/4"	2080 2080 81 7/8" 81 7/8"	740 740 29 1/8" 29 1/8"	<b>MIT1</b>		201.1	0.517	11		drawer with lock, universal system left or right
	2078 1800 81 3/4" 70 7/8"	2080 2080 81 7/8" 81 7/8"	740 740 29 1/8" 29 1/8"	<b>MIT2</b>		196.1	0.501	11		drawer with lock, universal system left or right
	2497 2219 98 1/4" 87 3/8"	2080 2080 81 7/8" 81 7/8"	740 740 29 1/8" 29 1/8"	<b>MIT1KD</b>		221.1	0.696	11		drawer with lock, universal system left or right
	2297 2019 90 3/8" 79 1/2"	2080 2080 81 7/8" 81 7/8"	740 740 29 1/8" 29 1/8"	<b>MIT2KD</b>		216.1	0.679	11		drawer with lock, universal system left or right

**DEKS WITH ELECTRIC HEIGHT ADJUSTMENT AND MANAGERIAL SIDE STORAGE**

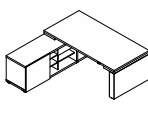
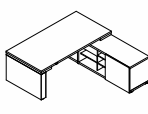
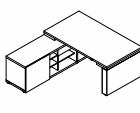
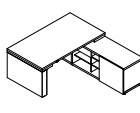

	2190 2190 86 1/4" 86 1/4"	2080 2080 81 7/8" 81 7/8"	760 1300 29 7/8" 51 1/8"	<b>MIT1RL</b>		316.9	1.448	14		
	2190 2190 86 1/4" 86 1/4"	2080 2080 81 7/8" 81 7/8"	760 1300 29 7/8" 51 1/8"	<b>MIT1RP</b>		316.9	1.448	14		
	1990 1990 78 3/8" 78 3/8"	2080 2080 81 7/8" 81 7/8"	760 1300 29 7/8" 51 1/8"	<b>MIT2RL</b>		306.4	1.383	14		
	1990 1990 78 3/8" 78 3/8"	2080 2080 81 7/8" 81 7/8"	760 1300 29 7/8" 51 1/8"	<b>MIT2RP</b>		306.4	1.383	14		

DESCRIPTION

 - NET WEIGHT

 VOLUME



 NUMBER OF PACKAGES

PRODUCT ILLUSTRATION	DIMENSIONS [mm]/[inch]			INDEX SYMBOL						COMMENTS
	WIDTH	DEPTH	HEIGHT			kg	m3	pcs		

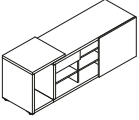
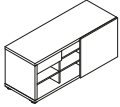

**MANAGERIAL STORAGE**

	1887 74 1/4"	572 22 1/2"	690 27 1/8"	<b>MIT5</b>		120.4	0.280	8		storage with HPL extension, drawer with lock, sliding door
	1500 59"	572 22 1/2"	652 25 5/8"	<b>MIT6</b>		98.0	0.233	4		drawer with lock, sliding door

**MOBILE PEDESTAL WITHOUT HANDLES WITH HPL TOP AND FRONT**

	416 16 3/8"	600 23 5/8"	587 23 1/8"	<b>SLD12HT</b>		23.0	0.158	1		mobile with suspension files drawer, drawers depth – 500mm
	416 16 3/8"	600 23 5/8"	587 23 1/8"	<b>SLD13HT</b>		23.0	0.158	1		drawers depth - 500mm

**MOBILE PEDESTAL WITHOUT HANDLES**

	428 16 7/8"	600 23 5/8"	586 23 1/8"	<b>MIT120</b>		32.0	0.154	1		
	428 16 7/8"	600 23 5/8"	586 23 1/8"	<b>MIT130</b>		35.0	0.154	1		

**PEDESTAL CUSHION**



	400 15 3/4"	600 23 5/8"	52 2"	<b>SKP13</b>		3.0	0.017	1		
---	----------------	----------------	----------	--------------	--	-----	-------	---	--	--

DESCRIPTION



 - NET WEIGHT

 VOLUME

 NUMBER OF PACKAGES

PRODUCT ILLUSTRATION	DIMENSIONS [mm]/[inch]			INDEX SYMBOL						COMMENTS
	WIDTH	DEPTH	HEIGHT			kg	m3	pcs		

MEETING TABLES

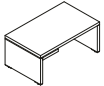
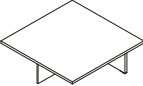
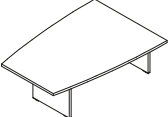
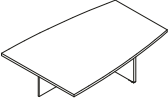
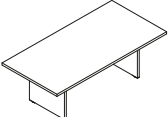

	800 31 1/2"	800 31 1/2"	740 29 1/8"	MIT10		36.0	0.107	3		column ø 50 mm, disc ø 500 mm
	1200 47 1/4"	1200 47 1/4"	740 29 1/8"	MIT17		64.0	0.150	3		column ø 100 mm, disc ø 620 mm
	1000 39 3/8"	600 23 5/8"	450 17 3/4"	MIT9		33.0	0.091	3		
	1400 55 1/8"	1400 55 1/8"	740 29 1/8"	MIT07		67.4	0.184	4		middle element of conference table – mediaport location A, B,G,H (1qty) or C,K (2qty)
	2000 2000 78 3/4" 78 3/4"	1400 1000 55 1/8" 39 3/8"	740 740 29 1/8" 29 1/8"	MIT06		89.2	0.275	3		begining element of conference table – mediaport location A, B,G,H (1qty) or C,K (2qty)
	2000 2000 78 3/4" 78 3/4"	1400 1000 55 1/8" 39 3/8"	740 740 29 1/8" 29 1/8"	MIT08		77.2	0.252	3		ending element of conference table – mediaport location A, B,G,H (1qty) or C,K (2qty)
	2200 86 5/8"	1100 43 1/4"	740 29 1/8"	MIT11		89.0	0.252	2		

DESCRIPTION



 - NET WEIGHT

 VOLUME

 NUMBER OF PACKAGES

PRODUCT ILLUSTRATION	DIMENSIONS [mm]/[inch]			INDEX SYMBOL						COMMENTS
	WIDTH	DEPTH	HEIGHT			kg	m3	pcs		

**STORAGES**

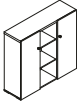
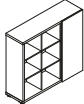
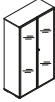
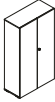
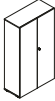
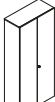

	916 36 1/8"	418 16 1/2"	879 34 5/8"	<b>MIT21</b>		49.0	0.117	1		
	1400 55 1/8"	422 16 5/8"	879 34 5/8"	<b>MIT18</b>		72.0	0.175	3		sliding door
	980 38 5/8"	418 16 1/2"	1280 50 3/8"	<b>MIT22</b>		87.0	0.572	1		file drawers
	1363 53 5/8"	418 16 1/2"	1280 50 3/8"	<b>MIT20</b>		84.0	0.211	2		
	1400 55 1/8"	422 16 5/8"	1280 50 3/8"	<b>MIT7</b>		98.0	0.226	3		sliding door
	916 36 1/8"	418 16 1/2"	1661 65 3/8"	<b>MIT16</b>		81.0	0.265	3		doors with transparent tempered glass and aluminum frame
	916 36 1/8"	418 16 1/2"	1661 65 3/8"	<b>MIT15</b>		80.0	0.229	2		filing cabinet
	916 36 1/8"	418 16 1/2"	1661 65 3/8"	<b>MIT8</b>		69.0	0.151	2		wardrobe/storage cabinet with slide-out hanger
	916 36 1/8"	418 16 1/2"	2077 81 3/4"	<b>MIT19</b>		98.0	0.266	3		filing cabinet

DESCRIPTION

 - NET WEIGHT

 VOLUME

 NUMBER OF PACKAGES

PRODUCT ILLUSTRATION	DIMENSIONS [mm]/[inch]			INDEX SYMBOL						COMMENTS
	WIDTH	DEPTH	HEIGHT			kg	m3	pcs		

**ACCESSORIES**

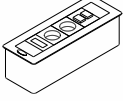
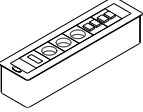
	267 10 1/2"	110 4 3/8"	93 3 5/8"	<b>S91E</b>		1.0	0.010	1		2 x 110V - 2 x RJ45
	426 16 3/4"	110 4 3/8"	93 3 5/8"	<b>S92E</b>		1.0	0.014	1		3 x 110V - 4 x RJ45