

TECHNICAL SPECIFICATION

COLOURS

COUNTER TOP - GLASS



WHITE, LACOBEL



FRONT HPL



73 HIGH GLOSS WHITE



74 HIGH GLOSS ORANGE



80 HIGH GLOSS LIME



81 HIGH GLOSS BURGUNDY



BODY



67 WHITE PASTEL



SUPPORTING LEG WHERE WORKTOPS CONNECT NL41



M015 WHITE SEMI-MATTE

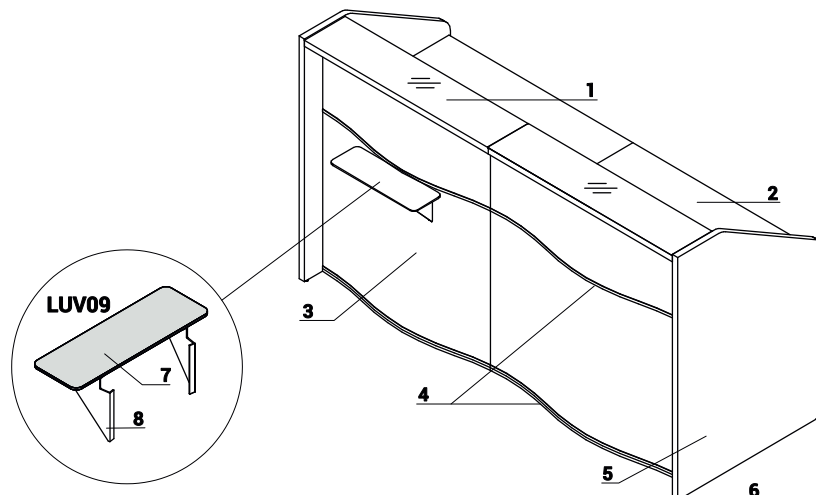

1. **Top** - MFC 36mm + Glass LACOBEL 4mm (40mm)
2. **Worktop** - MFC 28mm, PVC edge
3. **Front** - HPL - high gloss
4. **Decorative stripe** - PVC, colour M009 - aluminum semi-matte
5. **Low side panel** - MFC 28mm, PVC edge
6. **Leveling** - 10mm range
7. Shelf for reception counter, HPL mat 6mm
8. **Fixing element** - powder coated metal, color: M015 - metal white semi-matte

TECHNICAL SPECIFICATION

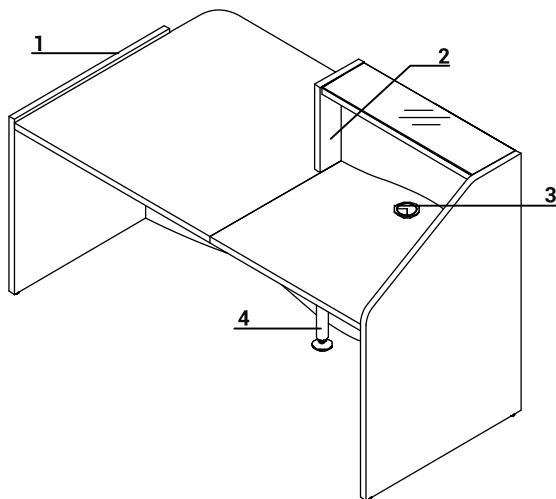

- 1. Low side panel - MFC 28mm, PVC edge
- 2. Side panel linking low and high fronts - MFC 28mm, PVC edge
- 3. Cable grommets - Ø80mm
- 4. Supporting leg NL41- required for connecting the tops

ATTENTION - Interior of the front in white

ENDING ELEMENTS APPLICATION

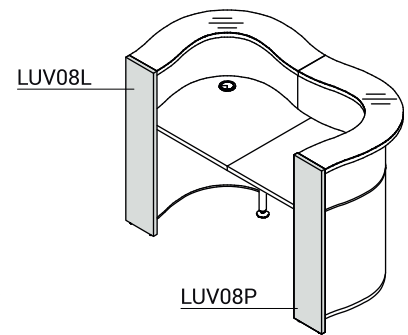
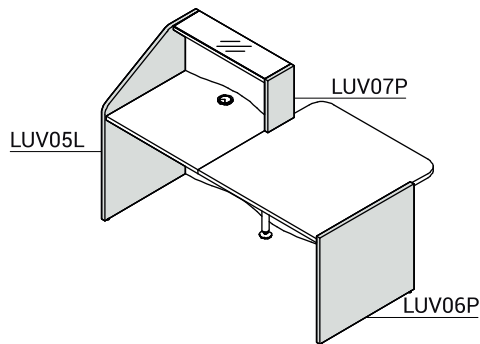
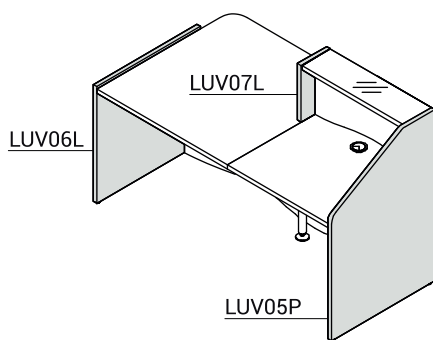

DIMENSIONS

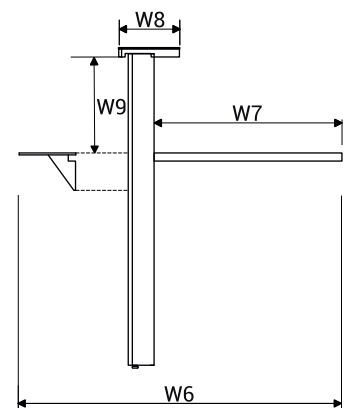
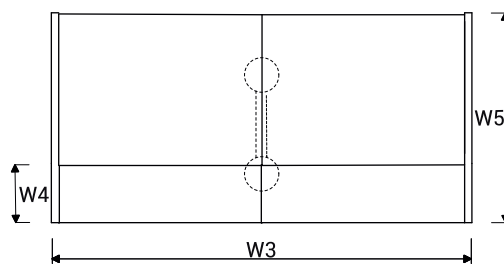
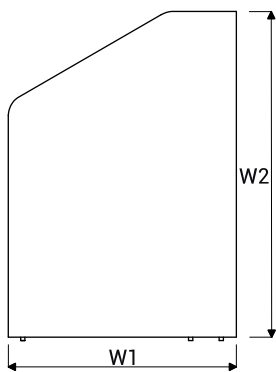

W1 - 770mm | W2 - 1103mm | W3 - 1556mm | W4 - 210mm | W5 - 770mm | W6 - 788mm | W7 - 650mm | W8 - 210mm | W9 - 330mm

RECEPTION DESKS SYSTEMS

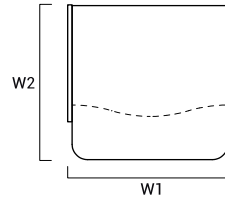
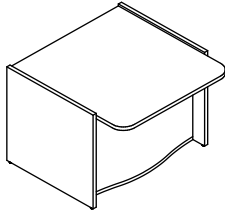

INDEX SYMBOL	DIMENSIONS [mm]						kg	m3	pcs		COMPONENTS
	W ₁	W ₂	D ₁	D ₂	H						
LUV10	1026	1119			755		50.0	0.167	4		LUV06L+LUV01+LUV06P
LUV101	826	1119			755		44.0	0.141	4		LUV06L+LUV011+LUV06P

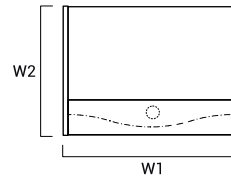
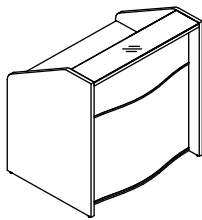

INDEX SYMBOL	DIMENSIONS [mm]						kg	m3	pcs		COMPONENTS
	W ₁	W ₂	D ₁	D ₂	H						
LUV11	806	770			1103		59.0	0.189	4		LUV05L+LUV02+LUV05P
LUV12	1026	770			1103		63.0	0.226	4		LUV05L+LUV03+LUV05P

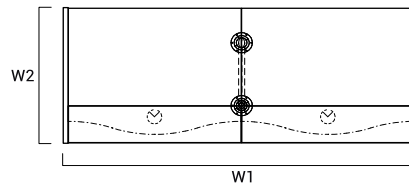
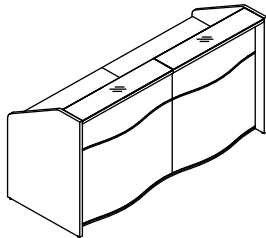

INDEX SYMBOL	DIMENSIONS [mm]						kg	m3	pcs		COMPONENTS
	W ₁	W ₂	D ₁	D ₂	H						
LUV13	1556	770			1103		90.0	0.380	7		LUV05L+2xLUV02+LUV05P+NL41
LUV14	1996	770			1103		98.0	0.453	7		LUV05L+2xLUV03+LUV05P+NL41

DESCRIPTION

- NET WEIGHT

VOLUME

NUMBER OF PACKAGES

RECEPTION DESKS SYSTEMS

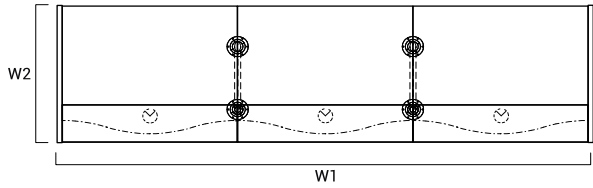
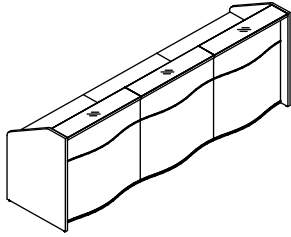

INDEX SYMBOL	DIMENSIONS [mm]						kg	m3	pcs	COMPONENTS
	W ₁	W ₂	D ₁	D ₂	H					
LUV15	2306	770			1103		121.0	0.570	10	LUV05L+3xLUV02+LUV05P+2xNL41
LUV16	2966	770			1103		133.0	0.681	10	LUV05L+3xLUV03+LUV05P+2xNL41

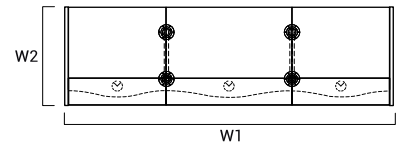
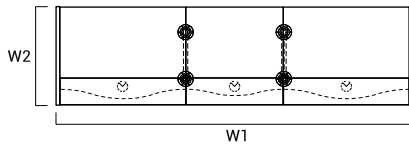
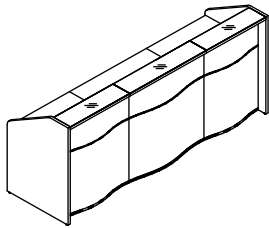

INDEX SYMBOL	DIMENSIONS [mm]						kg	m3	pcs	COMPONENTS
	W ₁	W ₂	D ₁	D ₂	H					
LUV17	2746	770			1103		129.0	0.644	10	LUV05L+2xLUV02+LUV03+LUV05P+2xNL41
LUV18	2526	770			1103		125.0	0.607	10	LUV05L+2xLUV03+LUV02+LUV05P+2xNL41

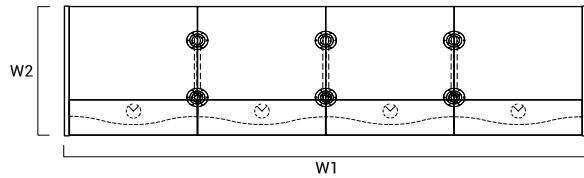
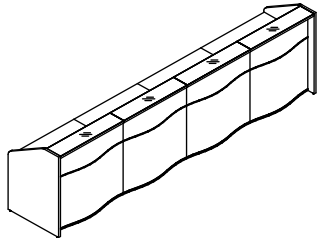

INDEX SYMBOL	DIMENSIONS [mm]						kg	m3	pcs	COMPONENTS
	W ₁	W ₂	D ₁	D ₂	H					
LUV19	3496	770			1103		152.0	0.761	13	LUV05L+4xLUV02+LUV05P+3xNL41
LUV20	3936	770			1103		168.0	0.909	13	LUV05L+4xLUV03+LUV05P+3xNL41

DESCRIPTION

- NET WEIGHT

VOLUME

NUMBER OF PACKAGES

RECEPTION DESKS SYSTEMS

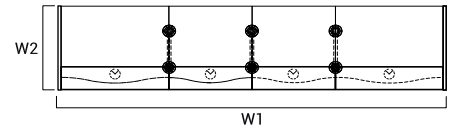
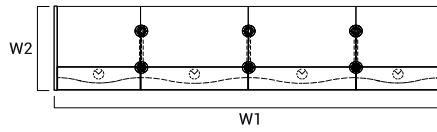
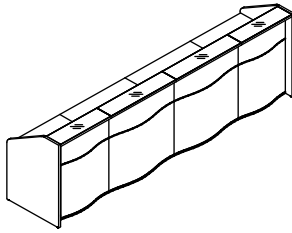

INDEX SYMBOL	DIMENSIONS [mm]						kg	m3	pcs	COMPONENTS
	W ₁	W ₂	D ₁	D ₂	H					
LUV21	3496	770			1103		160.0	0.835	13	LUV05L+2xLUV02+2xLUV03 +LUV05P+3xNL41

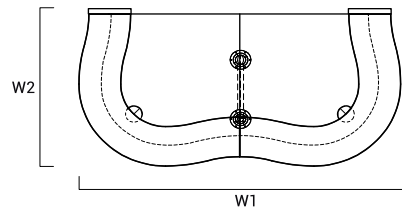
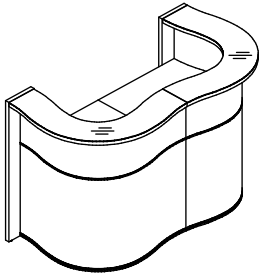

INDEX SYMBOL	DIMENSIONS [mm]						kg	m3	pcs	COMPONENTS
	W ₁	W ₂	D ₁	D ₂	H					
LUV22	1624	841			1103		84.0	0.575	7	LUV08L+2xLUV04+LUV08P+NL41

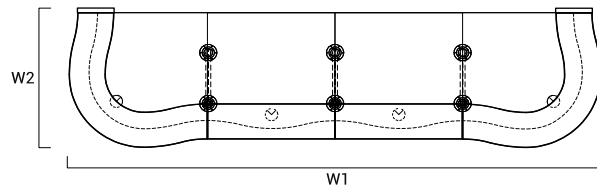
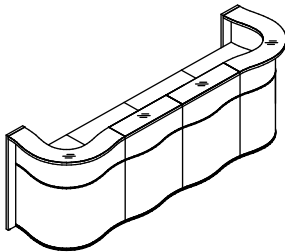

INDEX SYMBOL	DIMENSIONS [mm]						kg	m3	pcs	COMPONENTS
	W ₁	W ₂	D ₁	D ₂	H					
LUV23	3124	841			1103		146.0	0.957	13	LUV08L+2xLUV04+2xLUV02 +LUV08P+3xNL41
LUV24	3564	841			1103		154.0	1.031	13	LUV08L+2xLUV04+2xLUV03 +LUV08P+3xNL41

DESCRIPTION

- NET WEIGHT

VOLUME

NUMBER OF PACKAGES

RECEPTION DESKS SYSTEMS

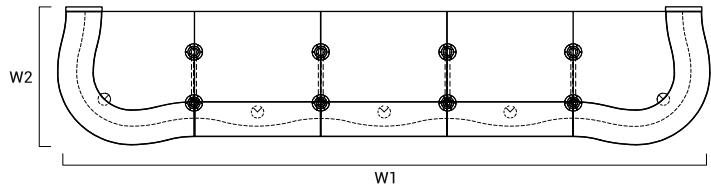
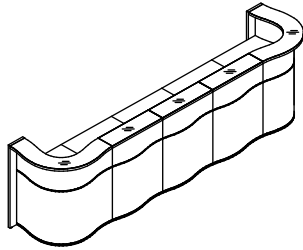

INDEX SYMBOL	DIMENSIONS [mm]						kg	m3	pcs	COMPONENTS
	W ₁	W ₂	D ₁	D ₂	H					
LUV25	3874	841			1103		177.0	1.148	16	LUV08L+2xLUV04+3xLUV02 +LUV08P+4xNL41
LUV26	4534	841			1103		189.0	1.259	16	LUV08L+2xLUV04+3xLUV03 +LUV08P+4xNL41

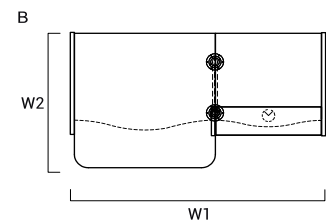
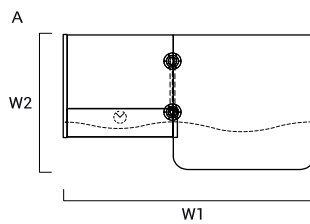
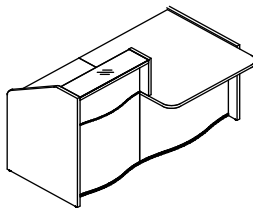

INDEX SYMBOL	DIMENSIONS [mm]						kg	m3	pcs	COMPONENTS
	W ₁	W ₂	D ₁	D ₂	H					
A LUV27L	1776	1019			1103		87.0	0.368	8	LUV06L+LUV01+LUV07L+LUV02 +LUV05P+NL41
B LUV27P	1776	1019			1103		87.0	0.368	8	LUV05L+LUV02+LUV07P+LUV01 +LUV06P+NL41
A LUV271L	1576	1019			1103		81.0	0.342	8	LUV06L+LUV01+LUV07L+LUV02 +LUV05P+NL41
B LUV271P	1576	1019			1103		81.0	0.342	8	LUV05L+LUV02+LUV07P+LUV01 +LUV06P+NL41
A LUV28L	1996	1019			1103		91.0	0.405	8	LUV06L+LUV01+LUV07L+LUV03 +LUV05P+NL41
B LUV28P	1996	1019			1103		91.0	0.405	8	LUV05L+LUV03+LUV07P+LUV01 +LUV06P+NL41
A LUV281L	1776	1019			1103		85.0	0.379	8	LUV06L+LUV01+LUV07L+LUV03 +LUV05P+NL41
B LUV281P	1776	1019			1103		85.0	0.379	8	LUV05L+LUV03+LUV07P+LUV01 +LUV06P+NL41

DESCRIPTION

- NET WEIGHT

VOLUME

NUMBER OF PACKAGES

RECEPTION DESKS SYSTEMS

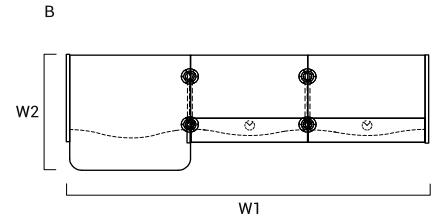
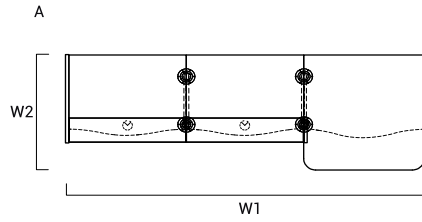
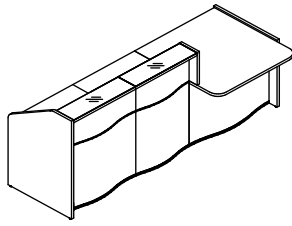

INDEX SYMBOL	DIMENSIONS [mm]					kg	m3	pcs	COMPONENTS
	W ₁	W ₂	D ₁	D ₂	H				
A LUV29L	2526	1019			1103	118.0	0.559	11	LUV06L+LUV01+LUV07L+2xLUV02+LUV05P+NL41
B LUV29P	2526	1019			1103	118.0	0.559	11	LUV05L+2xLUV02+LUV07P+LUV01+LUV06P+NL41
A LUV291L	2326	1019			1103	112.0	0.533	11	LUV06L+LUV011+LUV07L+2xLUV02+LUV05P+NL41
B LUV291P	2326	1019			1103	112.0	0.533	11	LUV05L+2xLUV02+LUV07P+LUV011+LUV06P+NL41
A LUV30L	2966	1019			1103	126.0	0.633	11	LUV06L+LUV01+LUV07L+2xLUV03+LUV05P+NL41
B LUV30P	2966	1019			1103	126.0	0.633	11	LUV05L+2xLUV03+LUV07P+LUV01+LUV06P+NL41
A LUV301L	2766	1019			1103	120.0	0.607	11	LUV06L+LUV011+LUV07L+2xLUV03+LUV05P+NL41
B LUV301P	2766	1019			1103	120.0	0.607	11	LUV05L+2xLUV03+LUV07P+LUV011+LUV06P+NL41

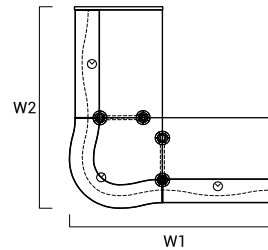
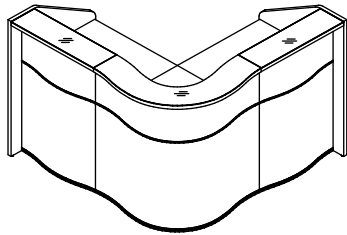

INDEX SYMBOL	DIMENSIONS [mm]					kg	m3	pcs	COMPONENTS
	W ₁	W ₂	D ₁	D ₂	H				
LUV35	1590	1590			1103	128.0	0.689	10	LUV05L+LUV02+LUV04+LUV02+LUV05P+2xNL41
LUV36	1810	1810			1103	136.0	0.763	10	LUV05L+LUV03+LUV04+LUV03+LUV05P+2xNL41

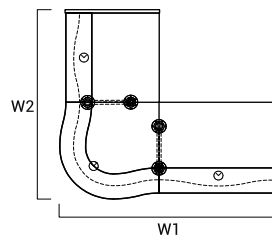
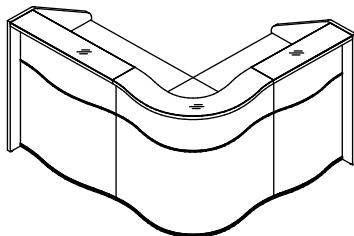

INDEX SYMBOL	DIMENSIONS [mm]					kg	m3	pcs	COMPONENTS
	W ₁	W ₂	D ₁	D ₂	H				
LUV37	1810	1590			1103	132.0	0.726	10	LUV05L+LUV03+LUV04+LUV02+LUV05P+2xNL41

DESCRIPTION

- NET WEIGHT

VOLUME

NUMBER OF PACKAGES

RECEPTION DESKS SYSTEMS

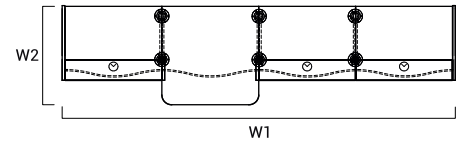
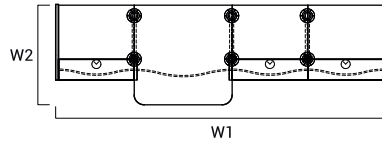
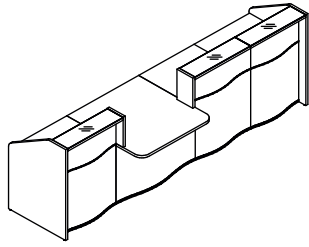

INDEX SYMBOL	DIMENSIONS [mm]					kg	m3	pcs	COMPONENTS
	W ₁	W ₂	D ₁	D ₂	H				
LUV31	3276	1019			1103	155.0	0.759	15	LUV05L+2xLUV02+LUV07P+LUV01+LUV07L+LUV02+LUV05P+3xNL41
LUV311	3076	1019			1103	149.0	0.733	15	LUV05L+2xLUV02+LUV07P+LUV011+LUV07L+LUV02+LUV05P+3xNL41
LUV32	3936	1019			1103	167.0	0.870	15	LUV05L+2xLUV03+LUV07P+LUV01+LUV07L+LUV03+LUV05P+3xNL41
LUV321	3736	1019			1103	161.0	0.844	15	LUV05L+2xLUV03+LUV07P+LUV011+LUV07L+LUV03+LUV05P+3xNL41

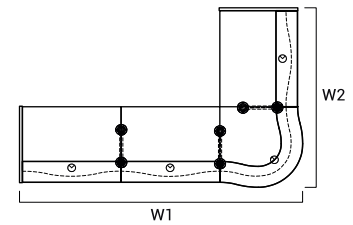
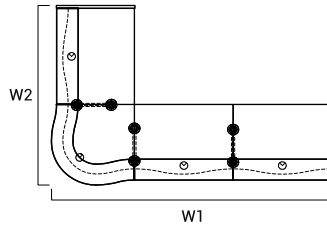
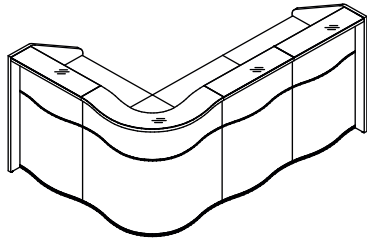

INDEX SYMBOL	DIMENSIONS [mm]					kg	m3	pcs	COMPONENTS
	W ₁	W ₂	D ₁	D ₂	H				
LUV41	2340	1590			1103	159.0	0.879	13	LUV05L+2xLUV02+LUV04+LUV02+LUV05P+3xNL41
LUV42	2780	1810			1103	171.0	0.990	13	LUV05L+2xLUV03+LUV04+LUV03+LUV05P+3xNL41

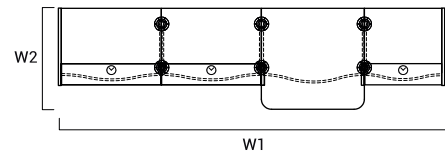
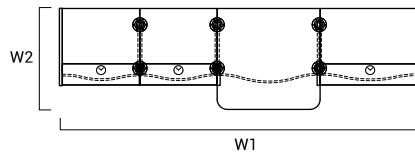
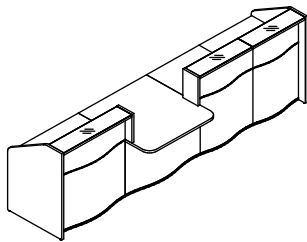

INDEX SYMBOL	DIMENSIONS [mm]					kg	m3	pcs	COMPONENTS
	W ₁	W ₂	D ₁	D ₂	H				
LUV33	3496	1019			1103	159.0	0.796	15	LUV05L+LUV03+LUV07P+LUV01+LUV07L+2xLUV02+LUV05P+3xNL41
LUV331	3296	1019			1103	153.0	0.770	15	LUV05L+LUV03+LUV07P+LUV011+LUV07L+2xLUV02+LUV05P+3xNL41
LUV34	3716	1019			1103	163.0	0.833	15	LUV05L+LUV02+LUV07P+LUV01+LUV07L+2xLUV03+LUV05P+3xNL41
LUV341	3516	1019			1103	157.0	0.807	15	LUV05L+LUV02+LUV07P+LUV011+LUV07L+2xLUV03+LUV05P+3xNL41

DESCRIPTION

- NET WEIGHT

VOLUME

NUMBER OF PACKAGES

RECEPTION DESKS SYSTEMS

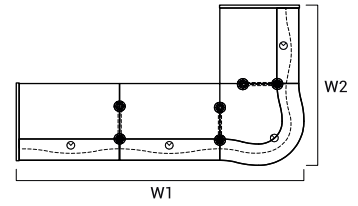
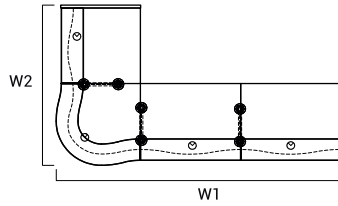
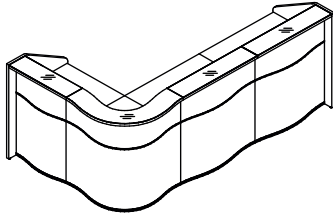

INDEX SYMBOL	DIMENSIONS [mm]					kg	m3	pcs	COMPONENTS
	W ₁	W ₂	D ₁	D ₂	H				
LUV43	2780	1591			1103	167.0	0.953	13	LUV05L+2xLUV03+LUV04+LUV02 +LUV05P+3xNL41
LUV44	2343	1813			1103	163.0	0.916	13	LUV05L+2xLUV02+LUV04+LUV03 +LUV05P+3xNL41

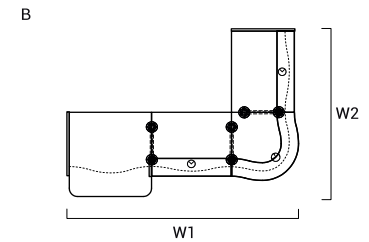
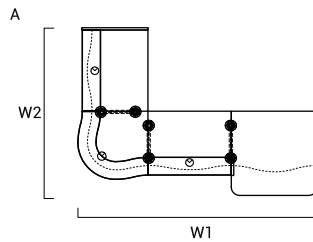
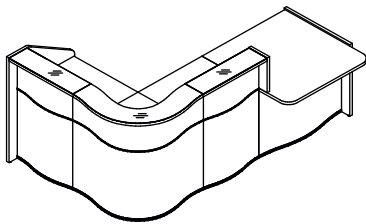

INDEX SYMBOL	DIMENSIONS [mm]					kg	m3	pcs	COMPONENTS
	W ₁	W ₂	D ₁	D ₂	H				
A LUV38L	2560	1590			1103	156.0	0.868	14	LUV06L+LUV01+LUV07L +LUV02+LUV04+LUV02+LUV05P +3xNL41
B LUV38P	2560	1590			1103	156.0	0.868	14	LUV05L+LUV02+LUV04+LUV02 +LUV07P+LUV01+LUV06P+3xNL41
A LUV381L	2360	1590			1103	150.0	0.842	14	LUV06L+LUV011+LUV07L+LUV02 +LUV04+LUV02+LUV05P+3xNL41
B LUV381P	2360	1590			1103	150.0	0.842	14	LUV05L+LUV02+LUV04+LUV02 +LUV07P+LUV011+LUV06P +3xNL41
A LUV39L	2780	1810			1103	164.0	0.942	14	LUV06L+LUV01+LUV07L+LUV03 +LUV04+LUV03+LUV05P+3xNL41
B LUV39P	2780	1810			1103	164.0	0.942	14	LUV05L+LUV03+LUV04+LUV03 +LUV07P+LUV01+LUV06P+3xNL41
A LUV391L	2580	1810			1103	158.0	0.916	14	LUV06L+LUV011+LUV07L+LUV03 +LUV04+LUV03+LUV05P+3xNL41
B LUV391P	2580	1810			1103	158.0	0.916	14	LUV05L+LUV03+LUV04+LUV03 +LUV07P+LUV011+LUV06P +3xNL41

DESCRIPTION

- NET WEIGHT

VOLUME

NUMBER OF PACKAGES

RECEPTION DESKS SYSTEMS

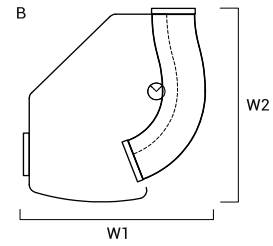
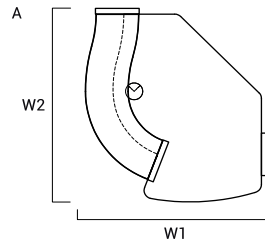
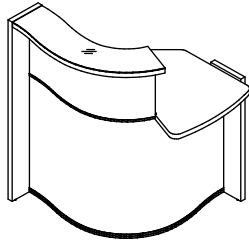

INDEX SYMBOL	DIMENSIONS [mm]						kg	m3	pcs	COMPONENTS
	W ₁	W ₂	D ₁	D ₂	H					
A LUV49L	858	925			1103		39.0	0.231	2	
B LUV49P	858	925			1103		39.0	0.231	2	

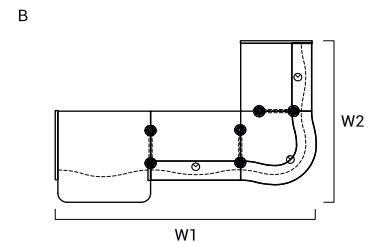
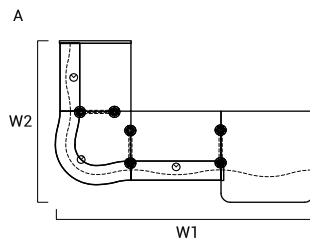
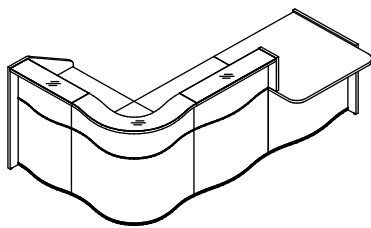

INDEX SYMBOL	DIMENSIONS [mm]						kg	m3	pcs	COMPONENTS
	W ₁	W ₂	D ₁	D ₂	H					
A LUV40L	2780	1792			1103		160.0	0.905	14	LUV06L+LUV01+LUV07L+LUV03 +LUV04+LUV02+LUV05P+3xNL41
B LUV40P	2780	1792			1103		160.0	0.905	14	LUV05L+LUV02+LUV04+LUV03 +LUV07P+LUV01+LUV06P+3xNL41
A LUV401L	2580	1792			1103		154.0	0.879	14	LUV06L+LUV011+LUV07L+LUV03 +LUV04+LUV02+LUV05P+3xNL41
B LUV401P	2580	1792			1103		154.0	0.879	14	LUV05L+LUV02+LUV04+LUV03 +LUV07P+LUV011+LUV06P +3xNL41

DESCRIPTION

- NET WEIGHT

VOLUME

NUMBER OF PACKAGES

RECEPTION DESKS SYSTEMS

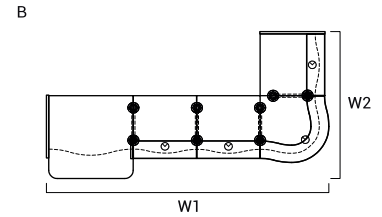
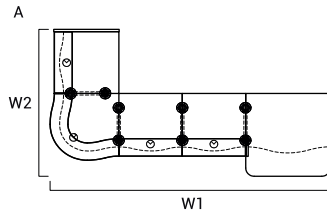
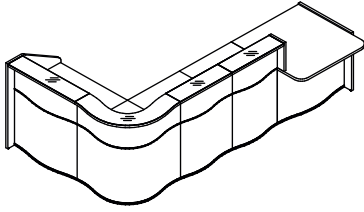

INDEX SYMBOL	DIMENSIONS [mm]					kg	m3	pcs	COMPONENTS
	W ₁	W ₂	D ₁	D ₂	H				
A LUV45L	3310	1792			1103	187.0	1.059	17	LUV06L+LUV01+LUV07L+2xLUV02+LUV04+LUV02+LUV05P+4xNL41
B LUV45P	3310	1792			1103	187.0	1.059	17	LUV05L+LUV02+LUV04+2xLUV02+LUV07P+LUV01+LUV06P+4xNL41
A LUV451L	3110	1792			1103	181.0	1.033	17	LUV06L+LUV011+LUV07L+2xLUV02+LUV04+LUV02+LUV05P+4xNL41
B LUV451P	3110	1792			1103	181.0	1.033	17	LUV05L+LUV02+LUV04+2xLUV02+LUV07P+LUV011+LUV06P+4xNL41
A LUV46L	3750	1810			1103	199.0	1.169	17	LUV06L+LUV01+LUV07L+2xLUV03+LUV04+LUV03+LUV05P+4xNL41
B LUV46P	3750	1810			1103	199.0	1.169	17	LUV05L+LUV03+LUV04+2xLUV03+LUV07P+LUV01+LUV06P+4xNL41
A LUV461L	3550	1810			1103	193.0	1.144	17	LUV06L+LUV011+LUV07L+2xLUV03+LUV04+LUV03+LUV05P+4xNL41
B LUV461P	3750	1810			1103	193.0	1.144	17	LUV05L+LUV03+LUV04+2xLUV03+LUV07P+LUV011+LUV06P+4xNL41

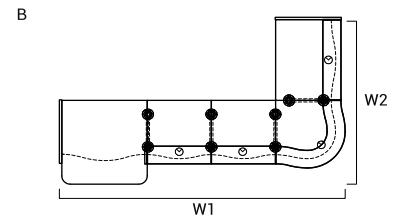
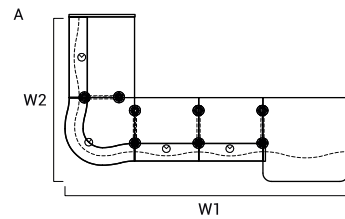
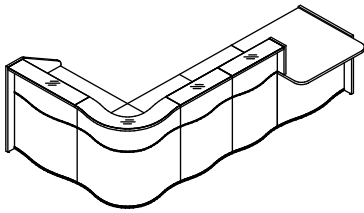



INDEX SYMBOL	DIMENSIONS [mm]					kg	m3	pcs	COMPONENTS
	W ₁	W ₂	D ₁	D ₂	H				
A LUV47L	3310	1810			1103	195.0	1.133	17	LUV06L+LUV01+LUV07L+2xLUV02+LUV04+LUV03+LUV05P+4xNL41
B LUV47P	3310	1810			1103	195.0	1.133	17	LUV05L+LUV03+LUV04+2xLUV02+LUV07P+LUV01+LUV06P+4xNL41
A LUV471L	3110	1810			1103	189.0	1.107	17	LUV06L+LUV011+LUV07L+2xLUV02+LUV04+LUV03+LUV05P+4xNL41
B LUV471P	3110	1810			1103	189.0	1.107	17	LUV05L+LUV03+LUV04+2xLUV02+LUV07P+LUV011+LUV06P+4xNL41
A LUV48L	3750	1792			1103	191.0	1.096	17	LUV06L+LUV01+LUV07L+2xLUV03+LUV04+LUV02+LUV05P+4xNL41
B LUV48P	3750	1792			1103	191.0	1.096	17	LUV05L+LUV02+LUV04+2xLUV03+LUV07P+LUV01+LUV06P+4xNL41
A LUV481L	3550	1792			1103	185.0	1.070	17	LUV06L+LUV011+LUV07L+2xLUV03+LUV04+LUV02+LUV05P+4xNL41
B LUV481P	3550	1792			1103	185.0	1.070	17	LUV05L+LUV02+LUV04+2xLUV03+LUV07P+LUV011+LUV06P+4xNL41

DESCRIPTION

- NET WEIGHT

VOLUME

NUMBER OF PACKAGES

PRODUCT ILLUSTRATION	DIMENSIONS [mm]			INDEX SYMBOL						COMMENTS
	WIDTH	DEPTH	HEIGHT			kg	m3	pcs		

COMPOSITION ELEMENTS

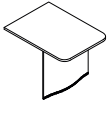
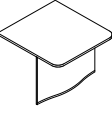
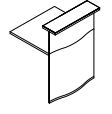
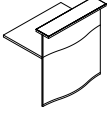
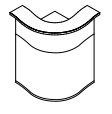
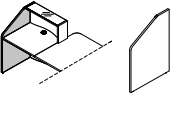
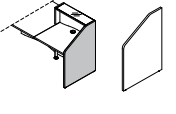
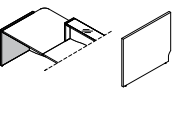
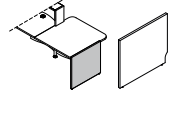
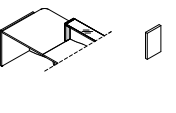
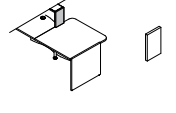

	750	1015	740	LUV011		22.0	0.092	2		
	970	1015	740	LUV01		28.0	0.118	2		
	750	763	1103	LUV02		29.0	0.128	2		
	970	763	1103	LUV03		33.0	0.165	2		
	815	815	1103	LUV04		36.0	0.246	2		
	770	28	1103	LUV05L		15.0	0.030	1		left
	770	28	1103	LUV05P		15.0	0.030	1		right
	770	28	755	LUV06L		11.0	0.024	1		left
	770	28	755	LUV06P		11.0	0.024	1		right
	216	28	363	LUV07L		2.0	0.004	1		left
	216	28	363	LUV07P		2.0	0.004	1		right

DESCRIPTION



 - NET WEIGHT

 VOLUME

 NUMBER OF PACKAGES

PRODUCT ILLUSTRATION	DIMENSIONS [mm]			INDEX SYMBOL						COMMENTS
	WIDTH	DEPTH	HEIGHT			kg	m3	pcs		

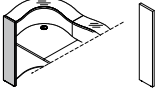
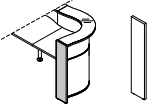
COMPOSITION ELEMENTS

	216	28	1103	LUV08L		5.0	0.010	1		left
	216	28	1103	LUV08P		5.0	0.010	1		right
	470	170	170	LUV09		1.7	0.014	0		67 - white pastel
	585	142	712	NL41		2.0	0.063	1		round profile leg

DESCRIPTION

 - NET WEIGHT

 VOLUME

 NUMBER OF PACKAGES